

Klant / Client

Afleveringsadres / Adresse de livraison

Datum / Date
..... / /

Ref. klant / Ref. client

2021

Alle gegevens zijn van **binnen** gezien / Toutes les données vues de l'**intérieur**

MARKISOLETTE

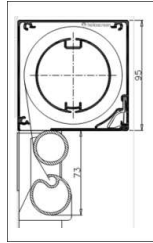
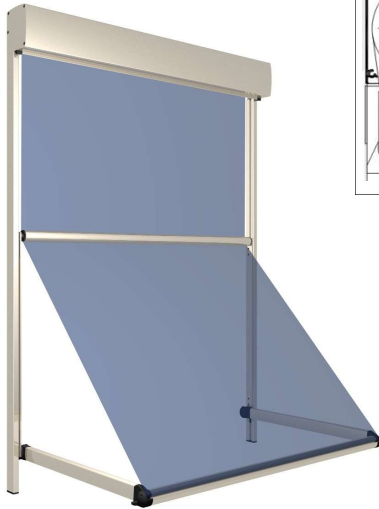

**Kast
Caisson**

95/95 85/85 diam.95

Voorgemonteerd
Pré-assemblé

**Afrolling
Déroulement**

90°
 130°

**Geleiding
Guidage**

**Opp. behandeling
Traitement profites**

nat. geanodiseerd
anodisé nat.

RAL

glansgraad / brillance:
 30% 70% structuur⁽³⁾

⁽³⁾Poedercode / code poudre:
.....

Doek / Toile

Serge 2165

Front (Std. uitv./Exec. std.)

Back

.....

kleurcode
n° coloris

kleur
couleur

Bediening / Commande

Manueel/Manuelle

Vaste slingerstang
Manivelle fixe

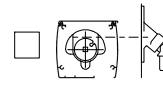

Afneembare slingerstang
Manivelle amovible

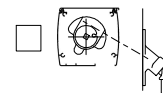

Elektrisch/Electrique

Selve SP motor
Moteur Selve SP

Hirschmann stekker
Fiche Hirschmann

Elektronische Selve SE
Selve SE Electronique

Somfy LT50

Somfy IO

Uitgang motorkabel / Sortie câble moteur

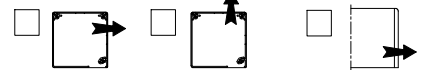

Maatvoering Mesures

van links naar rechts,
van binnen gezien
de gauche à droite,
vu de l'intérieur

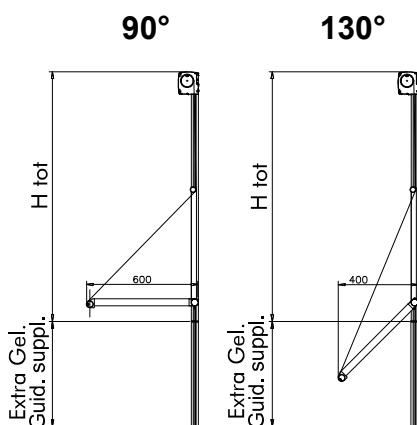
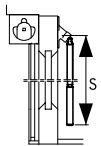

ENKEL / SIMPLE

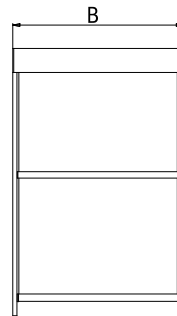

GEKOPPELD / ACCOUPLE (*)

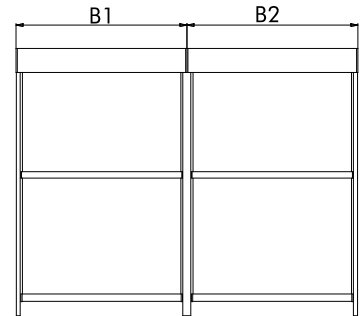

(*) Max 2 delen gekoppeld
Max. 2 parties accouplé

Indien de S-maat (lengte slinger) niet is opgegeven Si dimension S (longueur manivelle) n'est pas indiquée S = H-250mm

ref.nr. n° réf.	aantal pcs	B (mm)	B1 (mm)	B2 (mm)	H tot (mm)	Extra Gel. Guid. suppl. (mm)	S (mm)	bediening commande	
								LI/G	RE/D
								<input type="checkbox"/>	<input type="checkbox"/>
								<input type="checkbox"/>	<input type="checkbox"/>
								<input type="checkbox"/>	<input type="checkbox"/>
								<input type="checkbox"/>	<input type="checkbox"/>